



GRATA

VARNSDORF
TOS

**FLOOR TYPE
HORIZONTAL
BORING MILLS**



GRATA

WRD 130/150 (Q)

WRD 170 (Q)

New goals need new solutions

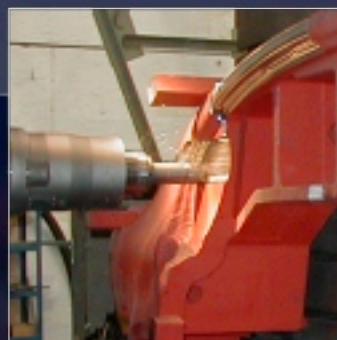

11/2012

TOS VARNSDORF a.s.

ABOUT COMPANY

www.tosvarnsdorf.com

Company TOS VARNSDORF a.s. situated in Varnsdorf, Czech Republic has a years-lasting tradition in machine tool production. The company was founded, under the name of Arno Plauert Machine Works, as early as 1903 and up to now it grew up into a big engineering company, known with its products all around the world.

The company's manufacturing program is based on the development, manufacture and sale of machine tools, integrated with a wide offer of services, such as:

- training for operators and maintenance workers
- technological studies
- installations of new machines
- warranty and after-warranty (extended) servicing
- spare parts sales
- overhauls and modernizations

In addition, the company provides for the services in the form of outwork offers (Metalworking, Measuring services, Chemical and Heat Treatment of Metals).

High engineering standards of TOS VARNSDORF a. s. products were recognized in 1996 when the company was awarded the ISO 9001 certificate.



PRODUCTION PROGRAM

PRODUCTION OF MACHINE TOOLS

- HORIZONTAL MILLING AND BORING MACHINES
- FLOOR TYPE HORIZONTAL BORING MILLS
- MACHINING CENTRES
- PORTAL TYPE MACHINING CENTRES
- SPECIAL MACHINES
- ACCESSORIES

SERVICES

- TECHNOLOGICAL SUPPORT: TRAINING, TECHNOLOGICAL STUDIES, ETC.
- SPARE PARTS, OVERHAULS AND MODERNIZATIONS
- COOPERATION (METALWORKING, MEASURING SERVICES, CHEMICAL AND HEAT TREATMENT OF METALS)

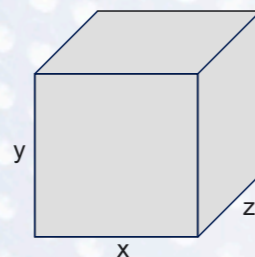

$$> 1 \text{ m}^3 (0.01\text{mm})$$

$$x > 1 \text{ m}$$

$$y > 1 \text{ m}$$

$$z > 1 \text{ m}$$

CONTENT

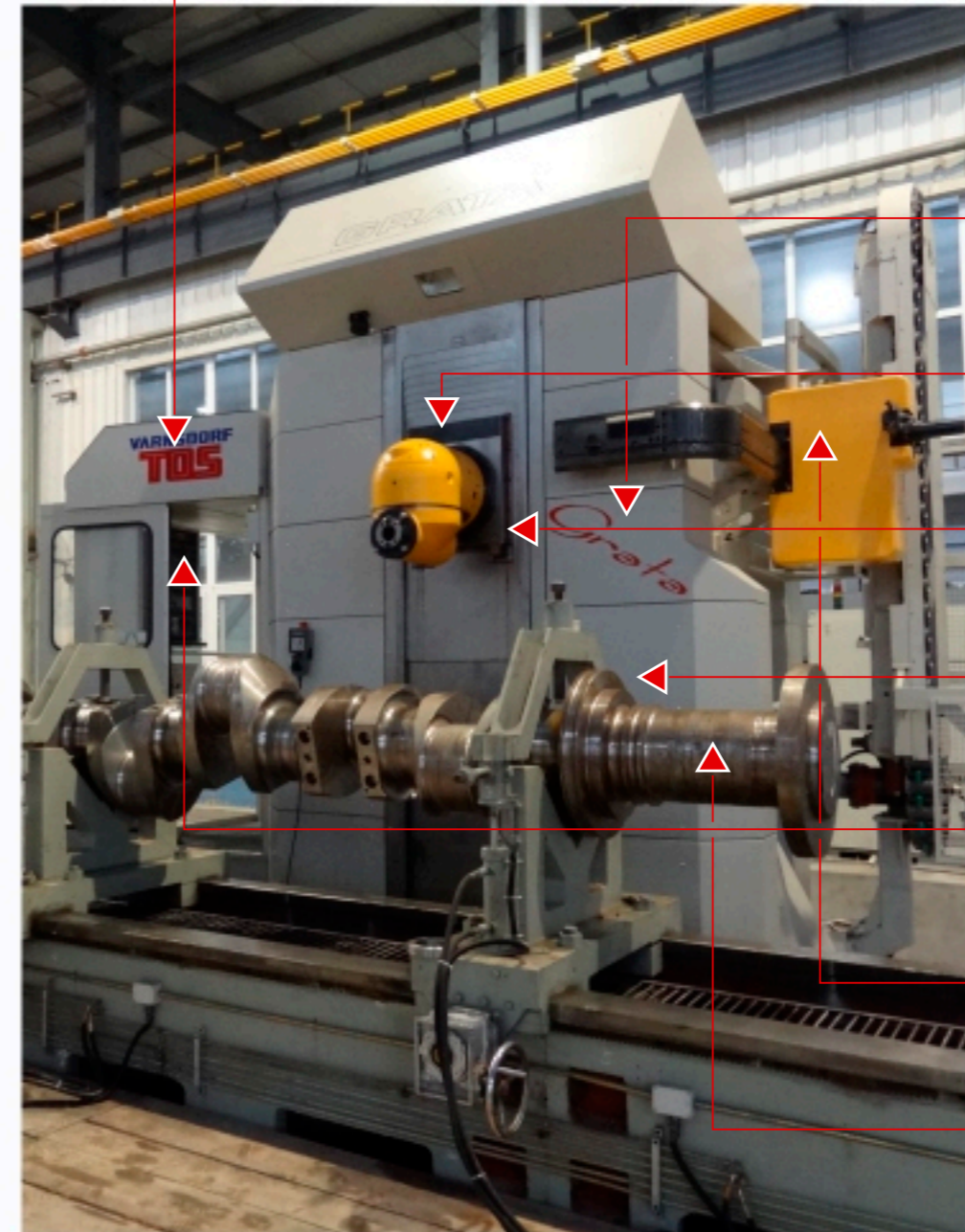

1	ABOUT COMPANY	1
2	CONTENT	1
3	FLOOR TYPE HORIZONTAL BORING MILLS GRATA	2
4	TECHNICAL PARAMETERS	2
5/6	RAM OF THE MACHINE	2
7/10	DESIGN OF MACHINE GROUPS	2
11/12	MACHINE CONTROL	2
13/15	OPTIONAL ACCESSORIES	2
16	TECHNOLOGIES	2
17/18	MACHINE LAYOUT	2

FLOOR TYPE HORIZONTAL BORING MILLS GRATA

www.tosvarnsdorf.com

GRATA floor type milling machines are designed to serve for precise coordinate milling, drilling, milling, and thread cutting. They are particularly suitable for the machining of box-, plate- and complex-shape work pieces made of cast iron, cast steel, steel or other materials machinable with cutting tools, and for large and weighty components.

The machines are equipped with an extending ram. The ram can be completed with a lot of accessories which enlarge the field of applications. Furthermore, the machines can be equipped with additional rotary tables or with clamping field composed of clamping plates.

The machines are well usable for batch production and complex process applications. The machines are controlled continuously in three axes (X, Y, Z), incidentally in further axes with regard to the used optional accessories from a continuous control system in positional relations.

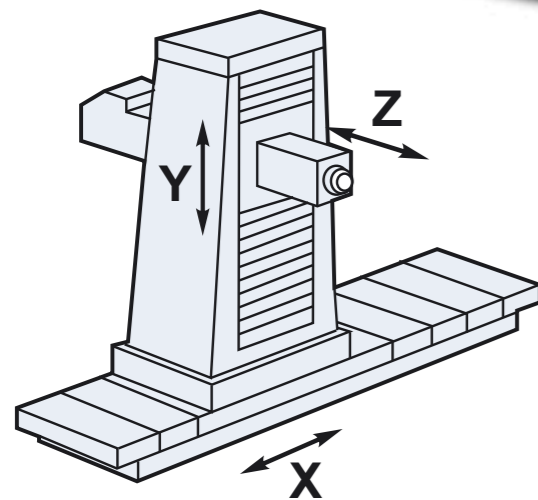
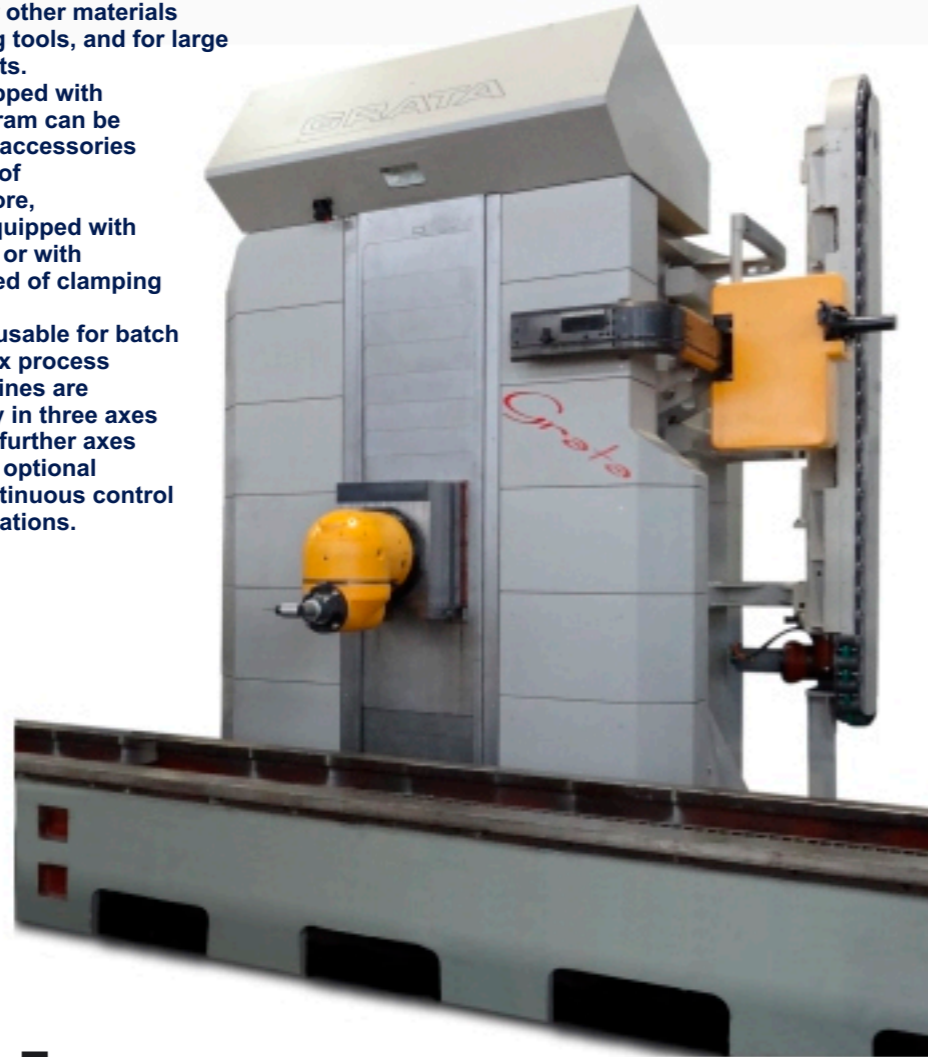

X max.	25,000 mm	984 inch
Y max.	3,000 mm	118.1 inch
Z	1,500 mm	59 inch

GRATA – TECHNICAL PARAMETERS

BASIC SPECIFICATIONS

HEADSTOCK *		
RAM size	500 x 500 mm	19.7 x 19.7 inch
Main motor speed range	10 - 5,000 RPM	
Main motor power max	37 kW	49.6 HP
Max. torque on driving shift	1,600 Nm	1,180 ft lb
COLUMN		
Column transverse travel X	5,000 - 25,000 mm (modules of 2,000 mm)	196.9 - 984 inch (modules of 78.7 inch)
Headstock vertical travel Y	1,600; 2,000; 2,500; 3,000 mm 63; 78.7; 98.4; 118.1 inch	
Ram stroke Z	1,500 mm	59 inch
FEEDS		
Feed range - X, Y, Z	1 - 15,000 mm.min ⁻¹	0.04 - 591 inch.min ⁻¹
Rapid traverse - X, Z	25,000 mm.min ⁻¹	985 inch.min ⁻¹
Rapid traverse - Y	15,000 mm.min ⁻¹	591 inch.min ⁻¹
Maximum feed forces in X, Y, Z axes	20 kN	

* The machine is equipped with an extending RAM as a standard. According to the customer's wish the RAM can be completed with an accessory like a spindle extension, milling head or facing head.

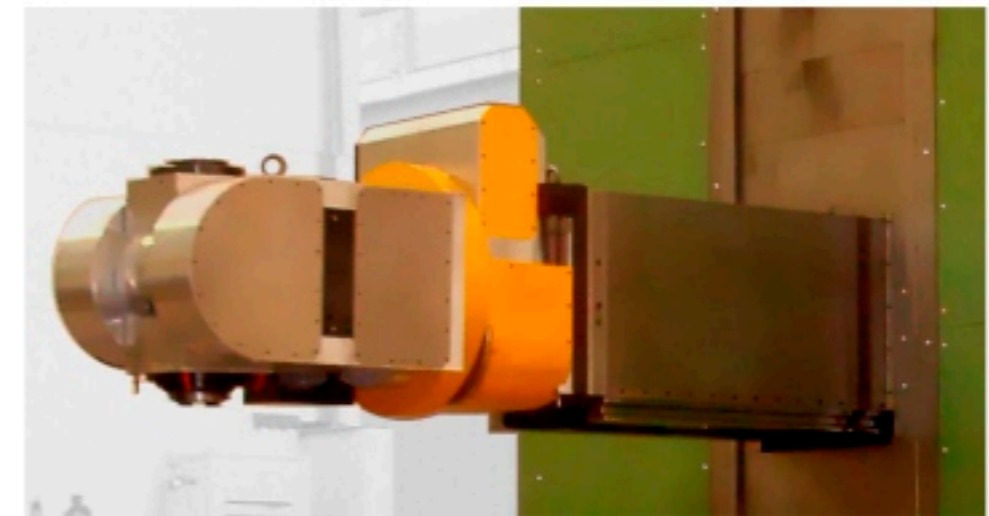

GRATA – RAM OF THE MACHINE

STANDARD TYPES OF ACCESSORIES APPLICABLE ON THE RAM FACE

MILLING HEADS

HUI 50



HPI 50

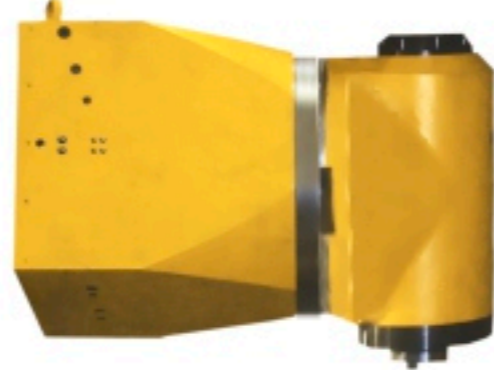

HOI 50



HV/E-H

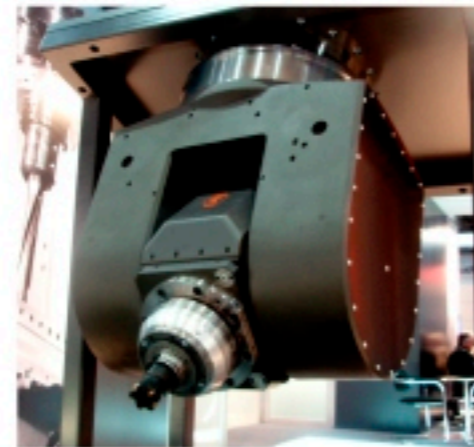

HV/V

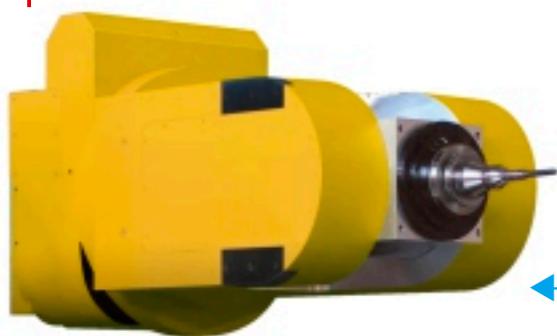

HV/E-H - the fork type milling head with electro spindle

HPI 50 - 1-axis vertical milling head automatically indexed

HUI 50 - 2-axes automatically indexed universal milling head

HOI 50 - 2-axes milling head orthogonal automatically indexed

HV/V - the fork type milling head with 1 or 2 axes

TECHNICAL PARAMETERS OF MILLING HEADS

		HUI 50	HPI 50	HOI 50	HV/V	HV/E-H
Number of axes		2	1	2	2	2
Max. speed	RPM	3,000	4,000	4,000	3,500	22,000
Max. transmitted power	kW	28	37	37	22	43
Max. torque	Nm	1,000	1,200	1,200	500	60
Positioning		index 2.5°	index 1°	index 1°	0.001°	0.001°

MILLING HEADS ARE AUTOMATICALLY FASTENED ON THE MACHINE, ANOTHER WAY THEY CAN BE ALSO APPLIED AS PERMANENTLY INTEGRATED.



AUTOMATIC CLAMPING OF ACCESSORIES

For the automatic clamping of milling heads and facing heads on the RAM face ensures the accessory magazine. Its execution (number of storage places, covers, etc.) is subject to prior consultation with the manufacturer.

SPINDLE EXTENSIONS

On the customer's wish the RAM of the machine can be also completed with a spindle extension of different lengths with following technical parameters.

Maximální otáčky	min ⁻¹	5 000
Maximální přenášený výkon	kW	37
Maximální krouticí moment	Nm	1 200



GRATA – DESIGN OF MACHINE GROUPS

www.tosvarnsdorf.com

THE MACHINE FRAME

The machine frame consists of a transverse bed with the column. On the column travels the headstock vertically. The bed is made of grey cast iron. Two linear guideways and a toothed rack for the column travel in X-coordinate are screwed up from the top of the bed. The column body is a steel weldment; there are four rails of LM guideways and two ball screws for Y axis drive on the column.



COMPENSATION

The headstock weight is balanced by the nitrogen cylinders placed on the machine column.

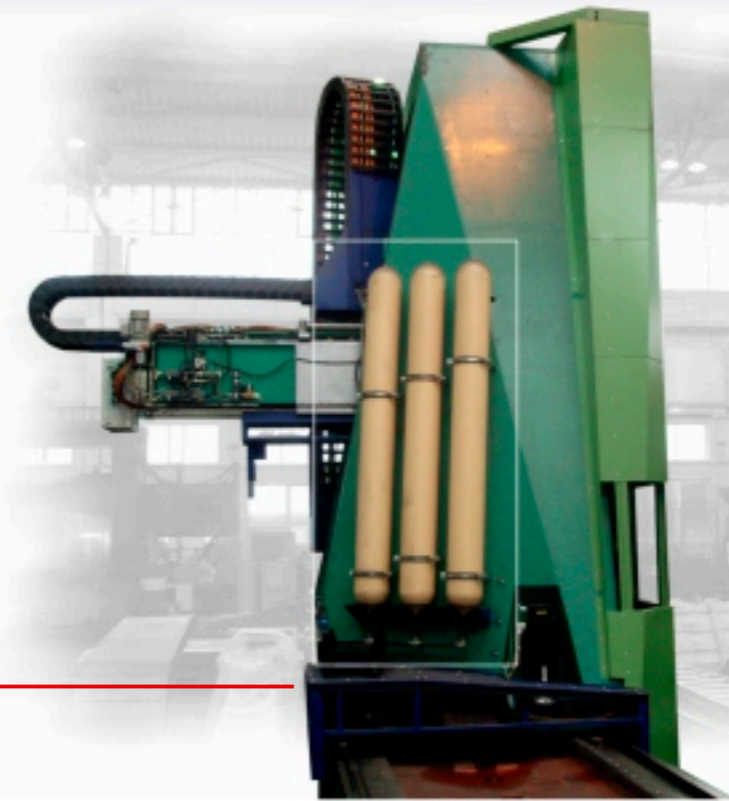

HEADSTOCK

Body of the headstock consists of two parts, fixed together. There is travelling ram in the headstock. There is electro-mechanical compensation of deflection during ram stroke as a part of headstock. A work spindle speed is operated by a powerful electric actuating drive via a robust gearbox. Two mechanical gears change automatically by means of an electrically-controlled shifter. Transmission from the gearbox to driving shaft is solved through torsion-resistant clutch. There is also motor including belt transmission of ball screw for ram travel, limit switches and ram travel encoders equipment on the headstock.

The machine is equipped with an extending RAM which can be completed with a wide selection of technological accessories.

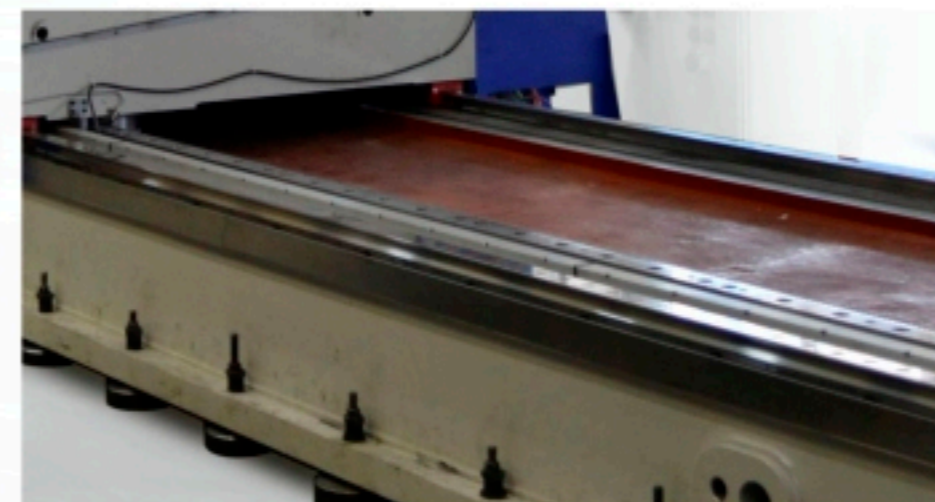

GUIDEWAYS OF MOVEABLE GROUPS

Guiding of the CNC controlled traveling axes have been designed as rolling type, preloaded, employing the compact linear roller pads. Travelling groups in CNC coordinates are permanently kept in positional mode. Guiding of the beds and the column is protected by steel telescopic covers.

GRATA – DESIGN OF MACHINE GROUPS

www.tosvarnsdorf.com

AUTOMATIC TOOL CHANGE

In case of the customer's demand, the machines can be equipped with attachment for automatic tool change (ATC) which consists of tool magazine and travelling tool manipulator with rotating two-arm hand.



THE ELECTRIC OUTFIT

An electric cabinet placed on a shop floor, outside the machine, houses electrical accessories except for actuating and switching elements. It contains a basic control system module, components controlling the servo- and spindle-drives plus other electrical elements supplied by leading specialized companies. Electric box is cooled with unit which is built into the door of this box.



HYDRO-AGGREGATE

The hydraulic unit is placed on the column and serves for controlling basic hydraulic functions of the machine.



OPERATION OF THE MACHINE

Machine controls are centralized on main operator's control panel located on the independent pillar outside the machine as a basic execution. In case of the customer's demand, the machines can be equipped also with the operator platform.



GRATA – MACHINE CONTROL

www.tosvarnsdorf.com

GRATA machines can be equipped with CNC control systems of different levels. As a standard, TOS Varnsdorf offers the machines with CNC control system HEIDENHAIN iTNC 530 or SINUMERIK 840 D. Coordinates are programmed with increment of 0.001 mm. An auxiliary portable hand panel and electronic hand-wheel serve for the machine control from another place.

CONTROL PANEL OF SINUMERIK 840 D CONTROL SYSTEM



CONTROL PANEL OF HEIDENHAIN iTNC 530 CONTROL SYSTEM



SYSTEM OF MEASURING

The linear axes X, Y, Z are equipped with direct measuring with the use of sealed HEIDENHAIN electro-optical measuring rules.



PORTABLE CONTROL PANEL SINUMERIK



PORTABLE CONTROL PANEL HEIDENHAIN (OPTION TYPE HR 520)



WE ALSO OFFER A SYSTEM OF SERVICES FOR THE PERMANENT SUPPORT OF CUSTOMERS:

TOSmessage

- ensures communication between the machine's control system and the customer's mobile phone. The customer is informed about the predefined statuses of the machine, e. g. the completion of an automatic cycle or possibly program interruption.

TOSwide

- the remote diagnostic system allows our service engineer to obtain required data about the status of the machine necessary to specify possible diagnostic messages about the non-standard condition of the machine's control system.

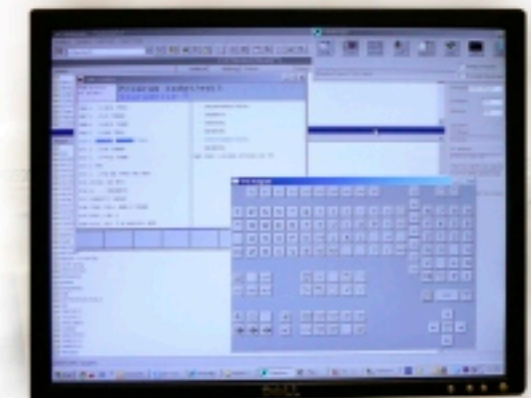
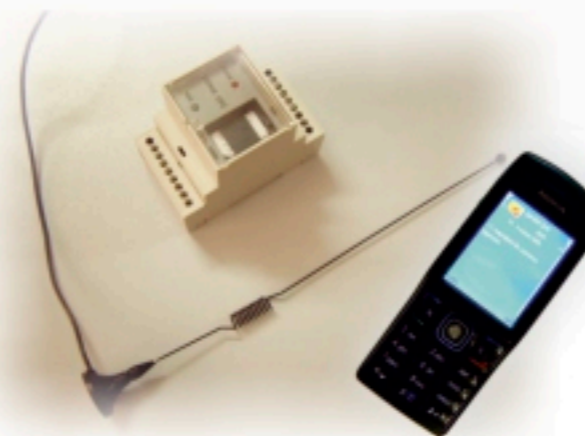

GRATA – OPTIONAL ACCESSORIES

www.tosvarnsdorf.com

FLOOR PLATES

UD 4 (4,020 x 1,885; 4,020 x 1,260; 2,420 x 1,885 mm // 158.3 x 74.2; 158.3 x 49.6; 95.3 x 74.2 inch) and UDS floor plates are used for clamping large and heavy workpieces.



CLAMPING CUBE

UK 500, UK 1000,
UK 2000, UK 2500

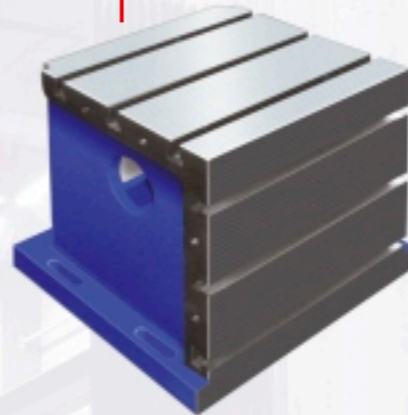

CHIP CONVEYOR

The length of a chip conveyor and its discharge height can be accommodated to user's needs.



ANGLE PLATE

Angle plates can be supplied in sizes 800; 950; 1,120; 1,450; 1,620; 2,000; 2,500 and 3,000 // 31.5; 37.4; 44.1; 57.1; 63.8; 78.7; 98.4; 118.1 inches.



TOOL COOLING DEVICE

Customer may choose from equipment for tool cooling with outside coolant supply CHZ GRATA or equipment enabling coolant supply through the spindle center and outside coolant supply CHOV GRATA.



ADDITIONAL ROTARY TABLES

S 5 – S 50
(option – table load up to 125 t)

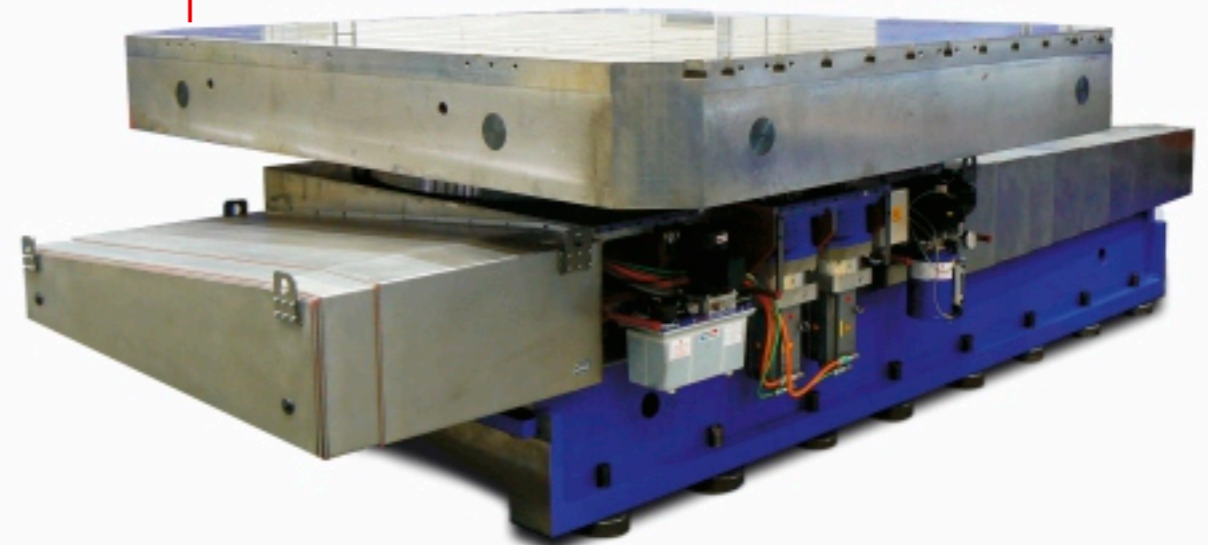

ANOTHER OPTIONAL ACCESSORIES YOU CAN FIND ON www.tosvarnsdorf.com/en/products/accessories/



GRATA – OPTIONAL ACCESSORIES

www.tosvarnsdorf.cz

GRATA – TECHNOLOGIES

ANOTHER MILLING HEADS

- automatically clamped on the machine

HPR 50



HUR 50



FACING HEADS

Facing heads are used for demanding technological operations with the possibility of continuous CNC control of the slide position.



HPR 50 - vertical manual milling head

HUR 50 - hand universal milling head

CONNECTION PLACE FOR ACCESSORIES

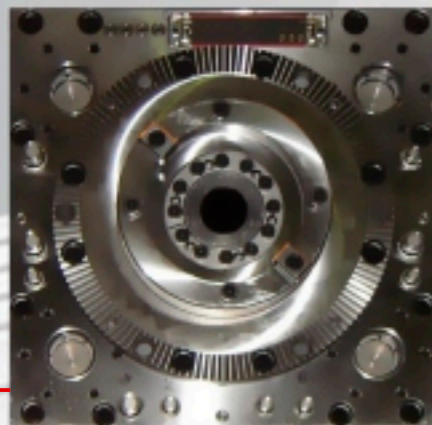

GRATA – MACHINE LAYOUT

www.tosvarnsdorf.com

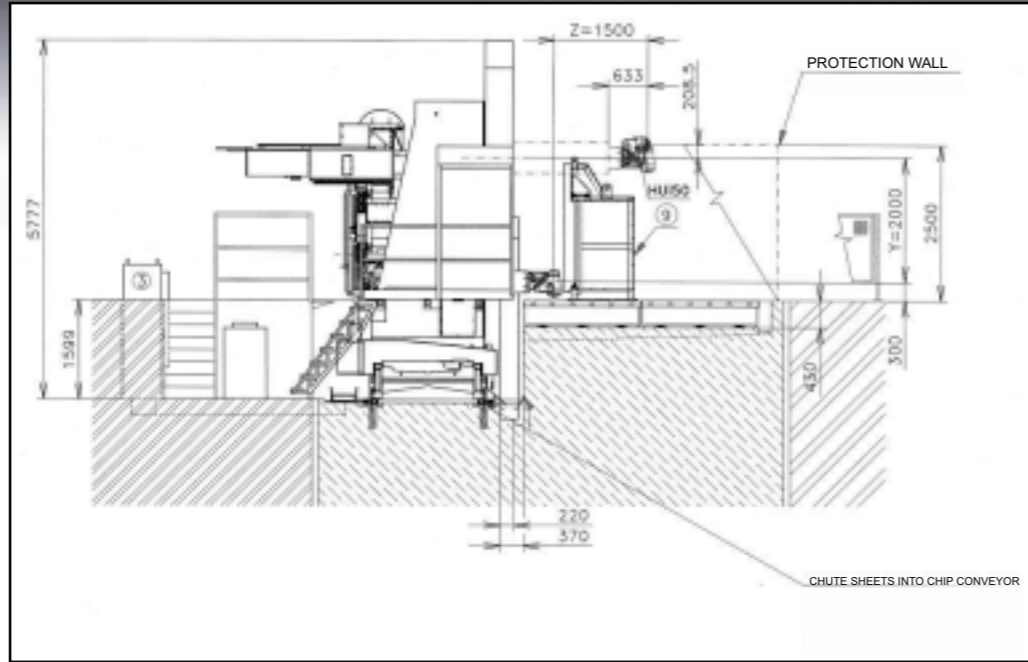

X = 5,000 mm // 196.9 inch
Y = 2,000 mm // 78.7 inch
Z = 1,500 mm // 59 inch
Rotary table (2,000 x 2,500 mm // 78.7 x 98.4 inch)
Floor plate 2 x UD4

- 1 Chip conveyor
- 2 Chip container
- 3 Switch cabinet
- 4 Coolant tank
- 5 Protective fencing
- 7 Filtration unit
- 8 Slotted floor
- 9 PICK UP station
- Conn. place to power supply

UPON THE CUSTOMER'S REQUEST, IT IS POSSIBLE TO EQUIP THE MACHINE WITH ADDITIONAL DEVICE OR PROCES ACCESSORIES.

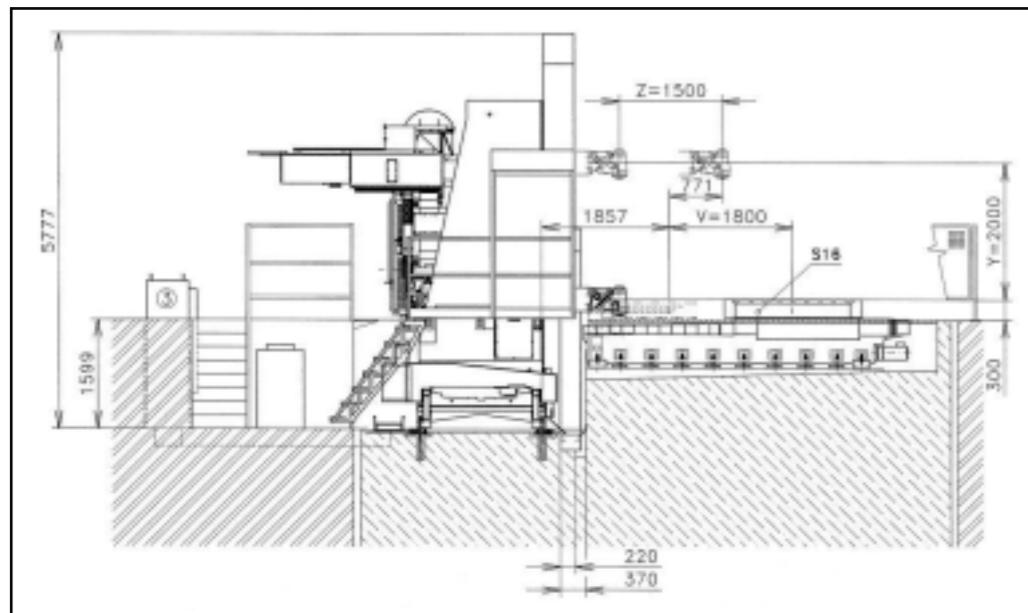

Data and features in the present catalogue are not binding. The producer reserves the right to alter them without advance notice at any time.

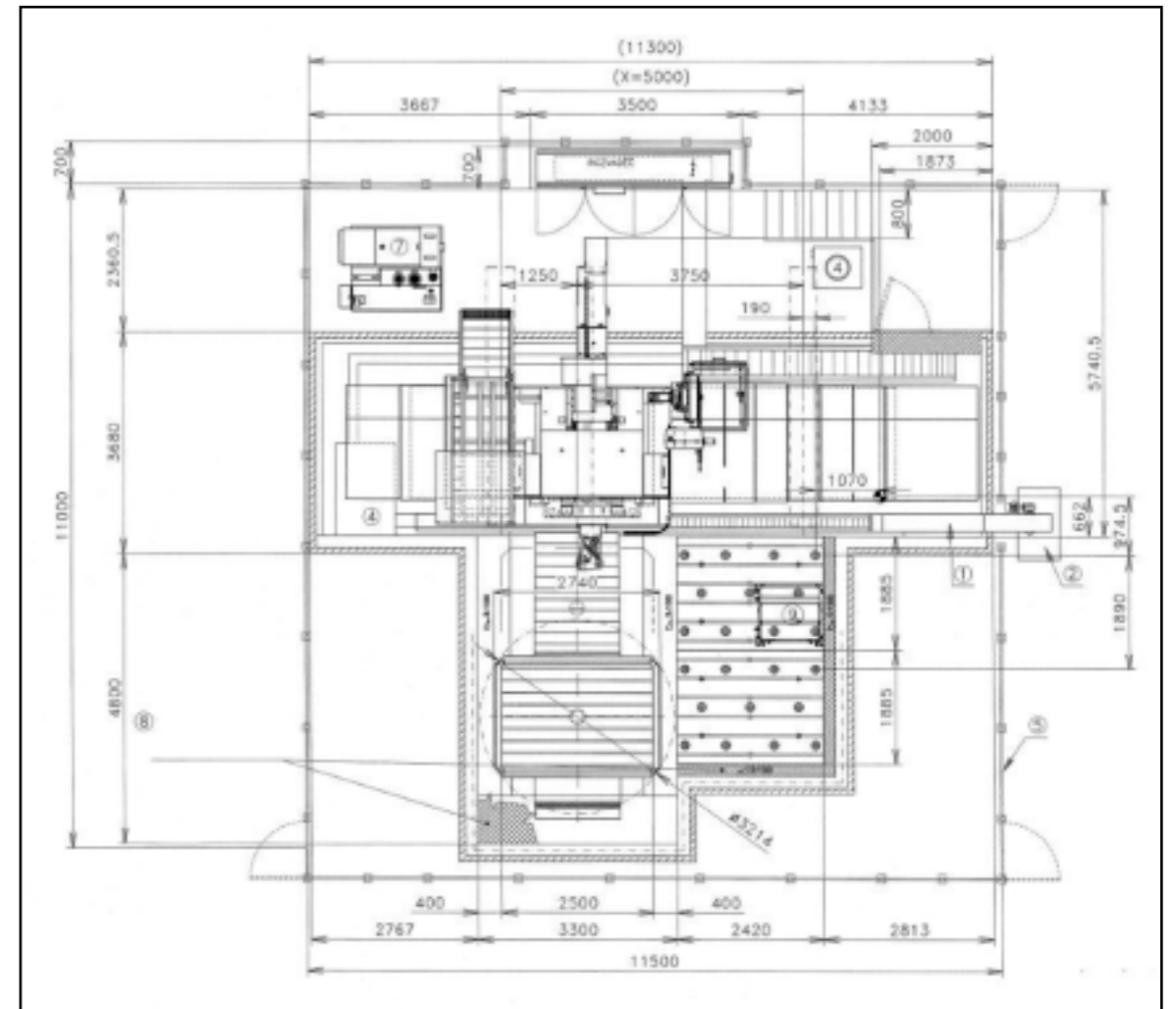
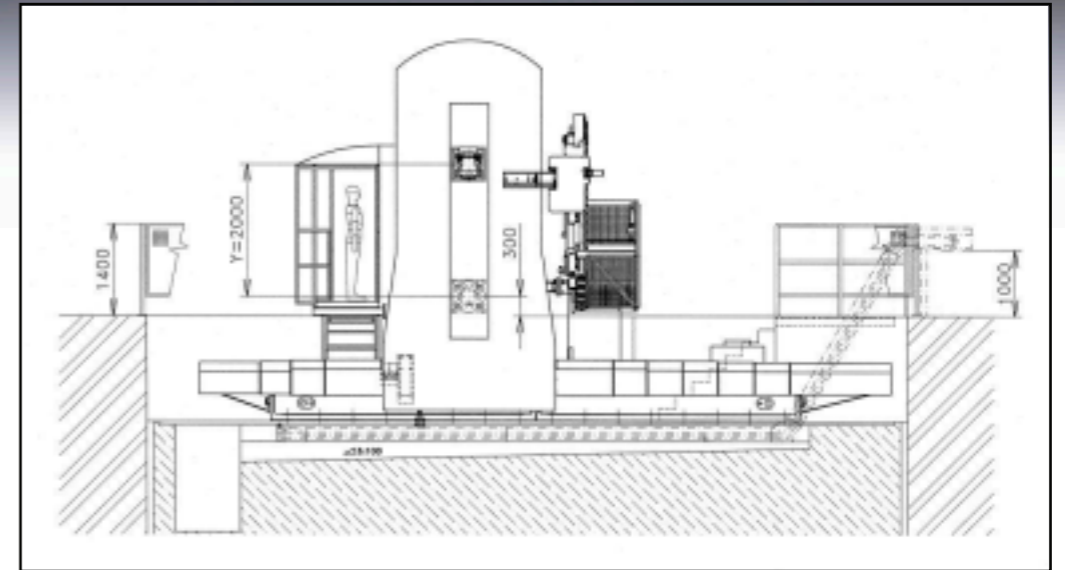

TOS VARNSDORF a.s.

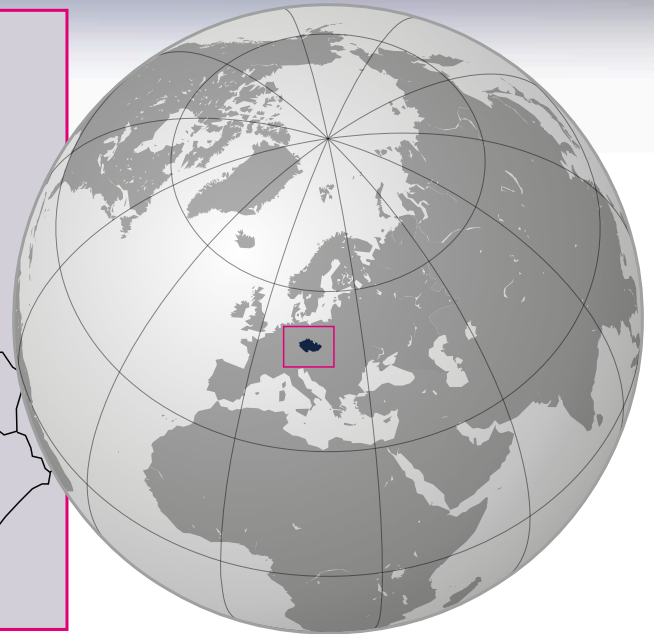

TOS VARNSDORF a.s.
Říční 1774, 407 47 Varnsdorf
Czech Republic

Phone: +420 412 351 203
Fax: +420 412 351 269
E-mail: info@tosvarnsdorf.com
www.tosvarnsdorf.com
www.tosvarnsdorf.eu

